

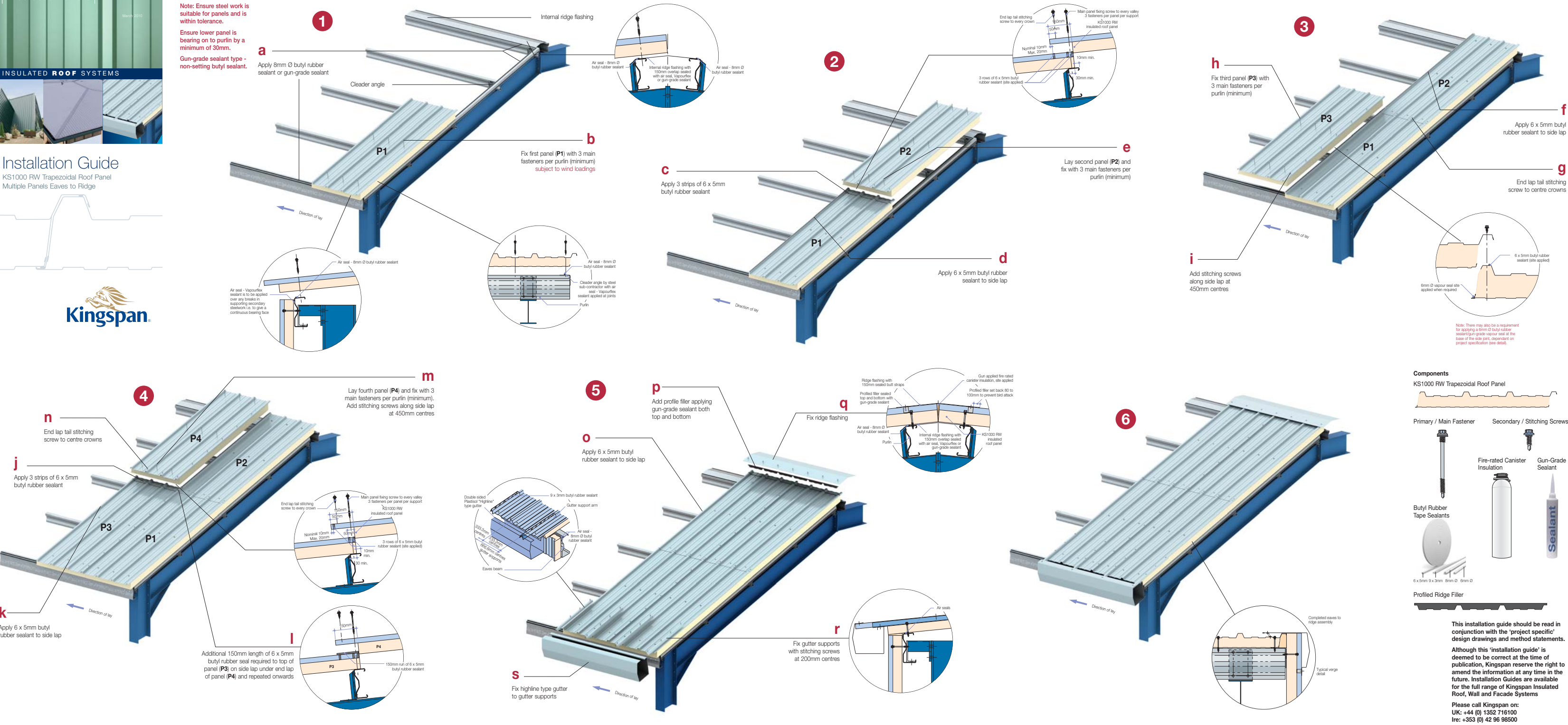

Installation Guide
KS1000 RW Trapezoidal Roof Panel
Multiple Panels Eaves to Ridge



Note: Ensure steel work is suitable for panels and is within tolerance.
Ensure lower panel is bearing on to purlin by a minimum of 30mm.
Gun-grade sealant type - non-setting butyl sealant.



Components
KS1000 RW Trapezoidal Roof Panel

Primary / Main Fastener Secondary / Stitching Screws

Butyl Rubber Tape Sealants Fire-rated Canister Insulation Gun-Grade Sealant

Profiled Ridge Filler

This installation guide should be read in conjunction with the 'project specific' design drawings and method statements. Although this 'installation guide' is deemed to be correct at the time of publication, Kingspan reserve the right to amend the information at any time in the future. Installation Guides are available for the full range of Kingspan Insulated Roof, Wall and Facade Systems. Please call Kingspan on: UK: +44 (0) 1352 716100 Ire: +353 (0) 42 96 98500



March 2019

Installation Guide

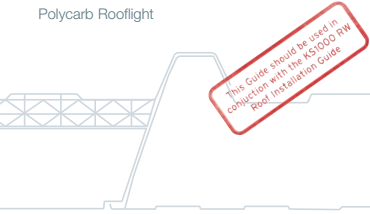

This Guide should be used in conjunction with the KS1000 RW Roof Installation Guide



1 Note: Apply 8mm Ø air seal to ridge, verge and eaves positions - See KS1000 RW Roof Installation Guide.
Gun-grade sealant type - non-setting butyl sealant. For use on roof panel only not rooflight.
Do not use silicone sealant with this product.

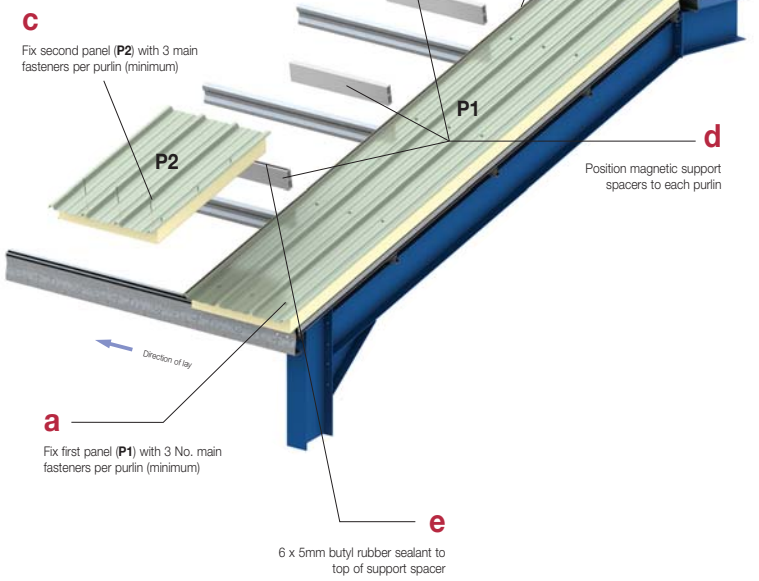

b Apply 6 x 5mm butyl rubber sealant to side lap

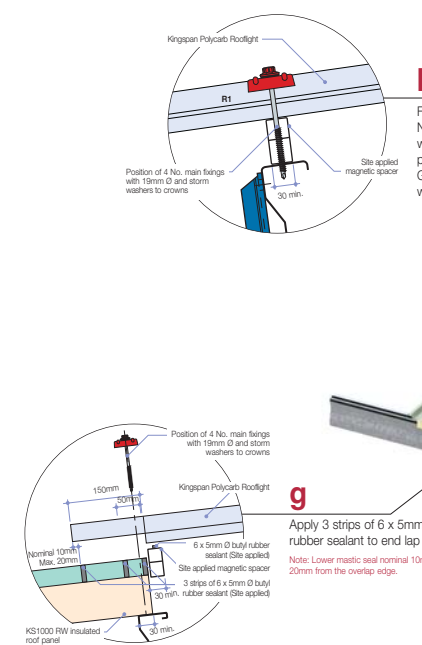

2

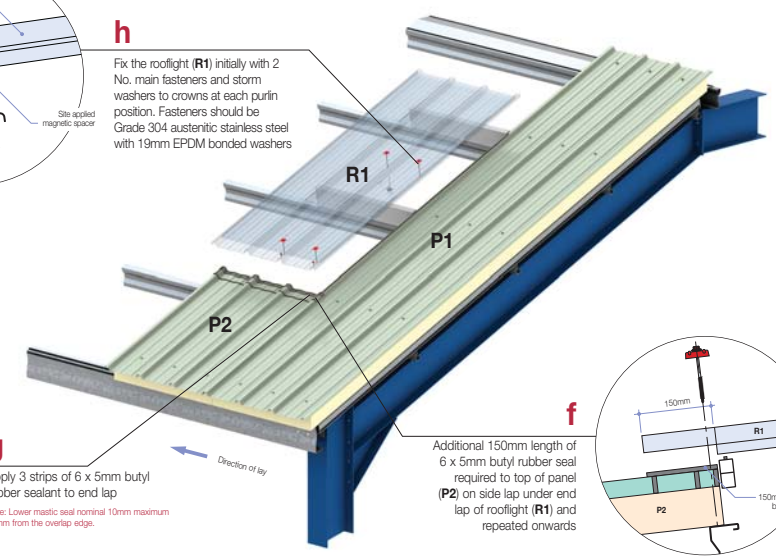

Note: Good practice would suggest that rooflight fastener heads and saddle washers are poppy red to identify the rooflight area.

3

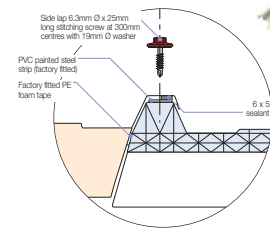
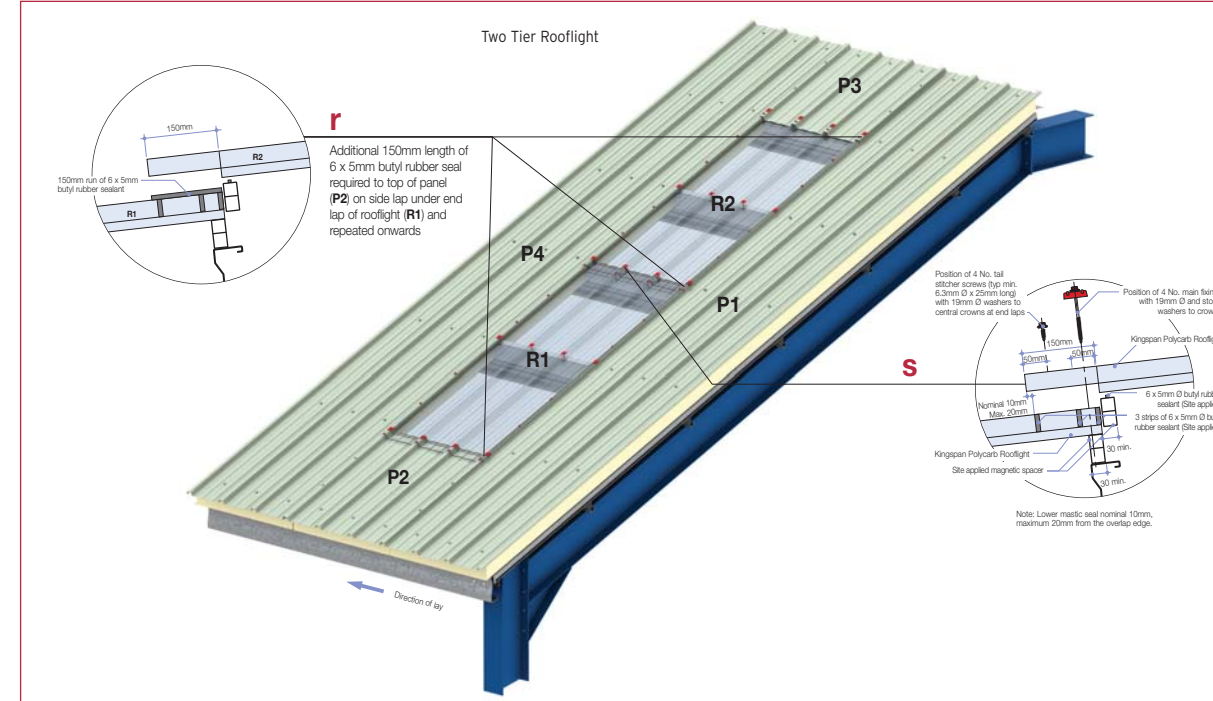
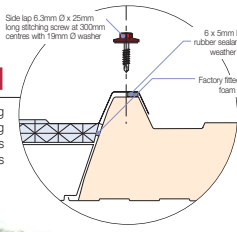
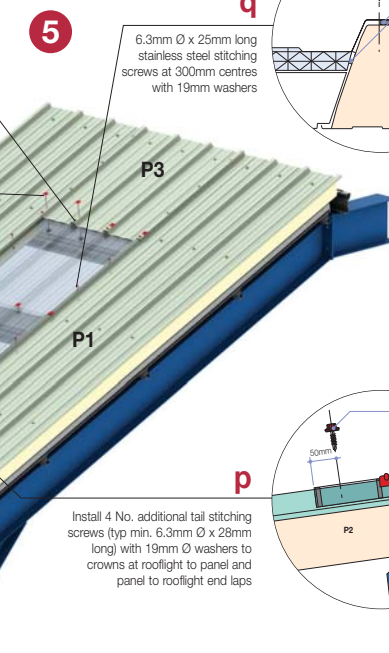
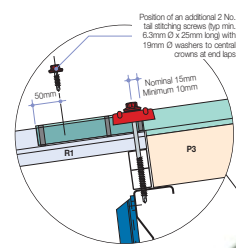
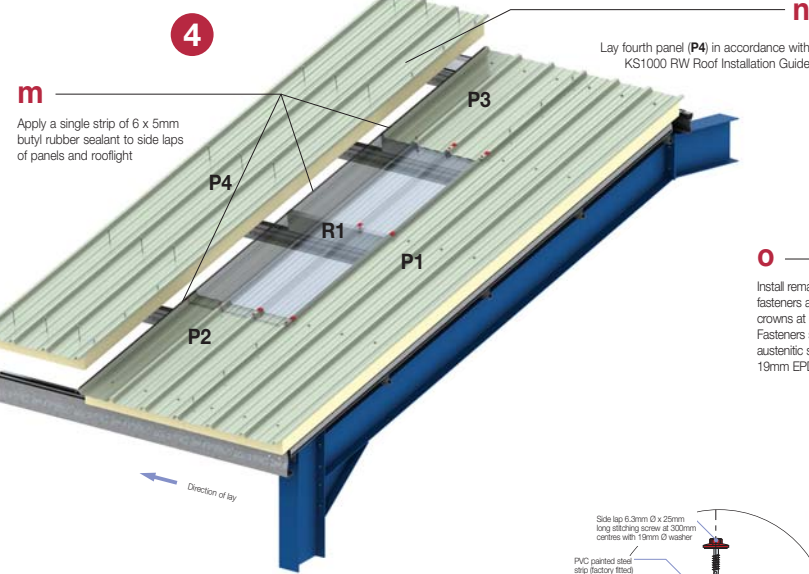
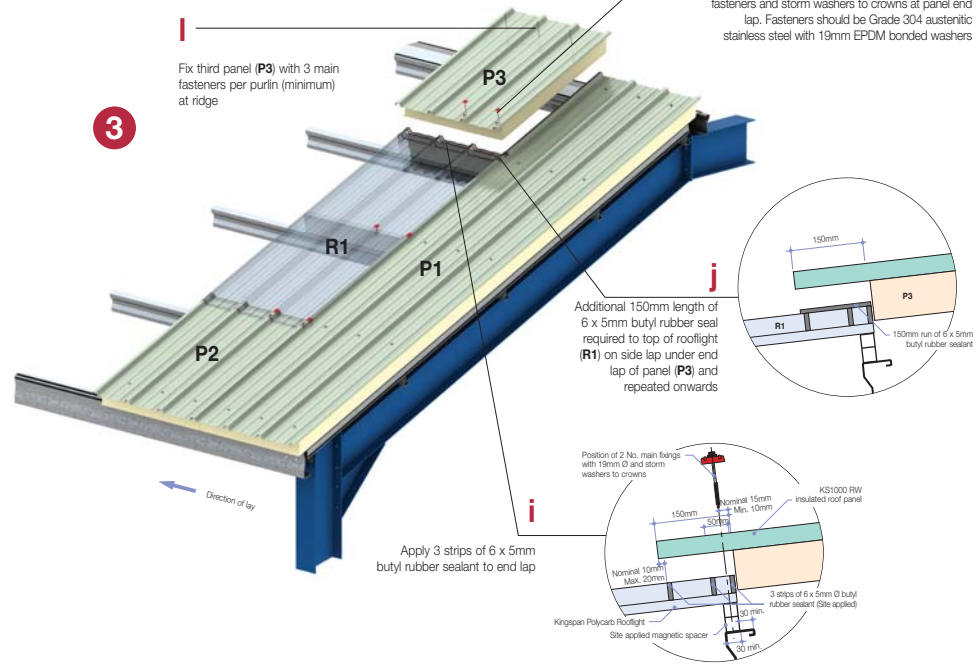

Components

Kingspan Polycarb Rooflight

Primary / Main Fasteners	Secondary / Stitching Screws

6 x 5mm 9mm Ø 6mm Ø

This installation guide should be read in conjunction with the 'project specific' design drawings and method statements.
Although this 'installation guide' is deemed to be correct at the time of publication, Kingspan reserve the right to amend the information at any time in the future. Installation Guides are available for the full range of Kingspan Insulated Roof, Wall and Facade Systems
Please call Kingspan on:
UK: +44 (0) 1352 716100
Ire: +353 (0) 42 96 98500